

Kar Zincir Grubu

Snow Chain Group



www.ckr-agro.com



KAR ZİNCİR GRUBU / SNOW CHAIN GROUP

X Seri Binek Araçlar / X Series Cars

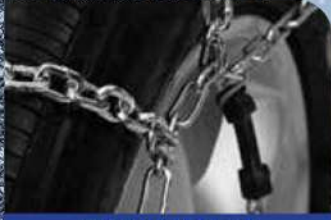

KOLAY MONTAJ
EASY MOUNTING



12 MM
12 MM



ÇELİK HALAT
STEEL ROPE

- Aracı hareket ettirmeden tamamen dış yüzey montaj.
- Manganez alaşımli kare kesitli çelik zincir ile uzun ömür.
- Parlak çinko kaplamalı ve aşınmaya karşı sertleştirilmiş zincir.
- Asimetrik x deseni ile her türlü ileri ve yan kaymalara karşı en yüksek çekiş ve fren emniyeti.
- Sarsıntısız güvenli sürüş rahatlığı.
- İç çevrede plastik boru ile korunmuş çelik halat.
- Pratik gerdirme sistemi.
- Ayaromatik sistemi ile lastiğe mükemmel oturuş.

- Quick and easy mounting without moving the car.
- Longlife with manganese alloy square link D-shape.
- Zinc-electro galvanized and anti - wear heat treatment.
- High traction and multidirectional braking safety due to X-pattern in cross chains.
- Smooth and comfortable driving.
- Internal flexible steel cable protected by hard plastic tube.
- Simple and quick tensioning system.
- Exact fitting to the tire due to its "Top Adjustment" system.

TÜRKİYE'DE İLK ÇELİK ZİNCİR

Sıradan zincirlere
göre 3 kat daha
dayamlı





KAR ZİNCİR GRUBU / SNOW CHAIN GROUP

X Seri Binek Araçlar / X Series Cars

GRUP	JANT EBATLARI / RIM SIZES											
	13"		14"		15"		16"		17" - 18"		19"-DİĞER	
3 ÜRÜN KODU 10.10.0003	155/70x13 165/60x13 165/65x13	175/60x13 140x13 145x13	135x14		145/65x15 125x15						155/65x345 160/65x340 560x12 165/70x12 155x12	
4 ÜRÜN KODU 10.10.0004	150x13 155x13 165/70x13 175/65x13	185/60x13 185/55x13 195/50x13 195/55x13	145x14 155/70x14 165/60x14 165/65x14	175/60x14 185/50x14 195/45x14	145/70x15 135x15 155/65x15						170/55x365 170/65x340 180/60x340 175/70x12	
5 ÜRÜN KODU 10.10.0005	165x13 560x13 590x13	175/70x13 185/65x13 195/60x13	155x14 520x14 560x14 165/70x14 175/65x14	185/55x14 185/60x14 195/55x14 195/50x14 215/40x14	145x15 155/70x15 165/60x15 185/50x15	175/55x15 195/45x15 165/65x15	195/40x16				170/65x365 185/65x340 195/55x365	
6 ÜRÜN KODU 10.10.0006	170x13 175x13 600x13	185/70x13 195/65x13 205/60x13	165x15 165/75x14 175/70x14 185/65x14 195/60x14	155x15 560x15 165/70x15 175/60x15	175/65x15 185/55x15 195/50x15	195/45x16 185/50x16					180/65x365 190/65x340 195/65x365 200/65x340	
7 ÜRÜN KODU 10.10.0007	195/70x13 205/65x13		175/75x14 185/70x14 195/65x14 205/55x14	175/70x15 185/60x15 195/55x15	205/50x15 205/55x15 185/65x15	215/40x16 205/40x16 195/50x16		175/55x17 205/40x17			180/65x390 200/55x390 200/60x365 210/55x365 220/50x365	
8 ÜRÜN KODU 10.10.0008	185x13 205/70x13	185x14 650x14 185/75x14 195/70x14	205/65x14 215/60x14 225/55x14 205/60x14	165x15 175x15 600x15 185/70x15	195/60x15 195/65x15 215/50x15 225/50x15	195/55x16 195/60x16 205/50x16	225/40x16 225/45x16 215/50x16	205/45x17 215/40x17			190/65x390 200/60x390 210/55x390 210/65x365 220/55x365	
9 ÜRÜN KODU 10.10.0009			195x14 205/70x14 225/60x14 195/75x14	180x15 185x15 195/70x15 205/65x15 215/60x15	225/55x15 195/75x15 205/60x15 205/60x15	175x16 175/75x16 205/55x16 225/50x16 195/65x16		205/50x17 215/45x17 225/40x17 215/40x18			225/55x390	
10 ÜRÜN KODU 10.10.0010			205x14 235/60x14 215/70x14	195x15 205/70x15 215/65x15 225/60x15	225/65x15 230/50x15 235/50x15 235/55x15	205/60x16 215/55x16 215/60x16	235/50x16 195/65x16 205/65x16	205/55x17 215/50x17 225/45x17 225/50x17	235/40x17 235/45x17 245/40x17		225/55x17 205/65x15	
11 ÜRÜN KODU 10.10.0011					215/70x15			225/55x16 225/60x16	245/45x17 255/40x17 235/40x18 225/45x18 255/35x18			235/35x19 225/40x19
12 ÜRÜN KODU 10.10.0012					235/70x15			235/60x16 225/65x16 245/55x16	225/60x17 235/50x17 245/45x18 245/40x18 255/35x18			245/35x19 245/40x19 255/35x19





KAR ZİNCİR GRUBU / SNOW CHAIN GROUP

4x4 ve Minibüs / 4x4 and Minibus



KOLAY MONTAJ
EASY MOUNTING



16 MM
16 MM



ÇELİK HALAT
STEEL ROPE

- Aracı hareket ettirmeden tamamen dış yüzey montaj.
- Manganez alaşımli kare kesitli çelik zincir ile uzun ömür.
- Parlak çinko kaplamalı ve aşınmaya karşı sertleştirilmiş zincir.
- Asimetrik x deseni ile her türlü ileri ve yan kaymalara karşı en yüksek çekiş ve fren emniyeti.
- Sarsıntısız güvenli sürüş rahatlığı.
- İç çevrede plastik boru ile korunmuş çelik halat.
- Pratik gerdirme sistemi.
- Ayaromatik sistemi ile lastiğe mükemmel oturuş.

- Quick and easy mounting without moving the car.
- Longlife with manganese alloy square link D-shape.
- Zinc-electro galvanized and anti - wear heat treatment.
- High traction and multidirectional braking safety due to X-pattern in cross chains.
- Smooth and comfortable driving.
- Internal flexible steel cable protected by hard plastic tube.
- Simple and quick tensioning system.
- Exact fitting to the tire due to its "Top Adjustment" system.

**TÜRKİYE'DE İLK
ÇELİK ZİNCİR**

Sıradan zincirlere
göre 3 kat daha
dayanıklı



www.ckr-agro.com



KAR ZİNCİR GRUBU / SNOW CHAIN GROUP

4x4 ve Minibüs / 4x4 and Minibus

GRUP	JANT EBATLARI / RIM SIZES									
	14"		15"		16"		17" - 18"		19"-DİĞER	
800 ÜRÜN KODU 10.20.0800	185x14 185/75x14 185/8Cx14 195/7Cx14	205/65x14 215/60x14 225/55x14	175x15 175/75x15 185/70x15 195/65x15	205/60x15 215/55x15 225/50x15	165/75x16 205/50x16		205/50x17 215/45x17		190/65x390 200/60x390 210/55x390 210/65x390	
900 ÜRÜN KODU 10.20.0900	195x14 195/75x14 205/70x14 225/60x14		180x15 185x15 185/75x15 195/70x15	215/60x15 225/55x15 205/65x15	175/75x16 215/50x16 205/55x16 225/45x16		225/45x17 235/40x17		195/380x195	
1000 ÜRÜN KODU 10.20.1000	205x14 205/75x14 215/75x14		195x15 195/75x15 205/70x15	205/75x15 215/65x15 225/60x15	205/60x16 185x16 185/75x16	205/65x16 215/60x16	245/40x17		650x16	
1040 ÜRÜN KODU 10.20.1040	255/55x14 245/60x14 225/65x14 215/70x14		215/70x15 195/85x15		195-65x16C 235/50x16 225/55x16	205/65x16 215/60x16				
1050 ÜRÜN KODU 10.20.1050	215x14		205/80x15 215/75x15 225/70x15	235/60x15 245/60x15	195x16 195/75x16 215/65x16	215/70x16 225/60x16 235/60x16	225/55x17 215/60x17 255/45x17 225/50x17		700x15 750x14 245/40x18	
1100 ÜRÜN KODU 10.20.1100			215x15 225/75x15 235/70x15	255/60x15 275/50x15	205x16 195/85x16 205/75x16 215/75x16 225/65x16	225/70x16 235/65x16 245/55x16 255/55x16	225/60x17 235/55x17 255/50x17		235/50x18 700x16 750x15 845x15	
1200 ÜRÜN KODU 10.20.1200			235/75x15 255/65x15 275/60x15		225/75x16 235/70x16		225/70x17 235/55x17 225/65x17		225/60x18 235/55x18 225/40x19	
1400 ÜRÜN KODU 10.20.1400			255/70x15 255/75x15 265/70x15		215x16 215/85x16 235/75x16	245/70x16 245/75x16	255/65x16 265/65x16 275/75x16	235/65x17 245/65x17	225/65x18 8,5x17,5 900x15	
1500 ÜRÜN KODU 10.20.1500			265/75x15 275/45x19 285/35x22 285/45x19		235/85x16 255/70x16 255/75x16 265/70x16		255/60x17 255/60x18 255/65x17	265/65x17 275/55x17	275/40x20 275/45x19 225/785x17,5	255/50x19 275/40x20
1600 ÜRÜN KODU 10.20.1600					265/75x16 275/70x16 235/85x16		265/70x17 275/55x17 225/75x17,5 235/75x17,5		315/35x20	
1700 ÜRÜN KODU 10.20.1700			825x15		825x16 275/70x16 255/85x16		9,5x17,5 700x18 750x18 8x19,5		285/50x20 650x20 700x20	





KAR ZİNCİR GRUBU / SNOW CHAIN GROUP

Merdiven Tipi Serme Seri / Ladder-Type
Snow Chains



KAUÇUK GERGİ TERTİBATI
RUBBER TIGHTENING TOOL

SERME ÇELİK ZİNCİR



ÇELİK MAHMUZ
V-BAR

- Kauçuk gergi tertibatı.
- Mahmuzlu merdiven modeli.
- Parlak çinko kaplamalı ve aşınmaya karşı sertleştirilmiş zincir.
- Rubber tightening tool.
- V-bar ladder-type.
- Zinc-electro galvanized and anti - wear heat treatment.

TÜRKİYE'DE İLK ÇELİK ZİNCİR

Sıradan zincirlere
göre 3 kat daha
dayanıklı





KAR ZİNCİR GRUBU / SNOW CHAIN GROUP

Merdiven Tipi Serme Seri / Ladder-Type
Snow Chains

ÜRÜN KODU	GRUP	JANT EBATLARI / RIM SIZES											
		12"		13"		14"		15"		16" - 18"		DİĞER	
10.30.0110	155x12	155x12 145x12 500x12 550x12	525x13 500x13 145x13										
10.30.0120	155x13	500Rx12 165x12 175/70x12	560x13 550x13 155x13	165/70x13 155/70x13									
10.30.0130	165x13		590x13 600x13 645x13	175/70x13 165x13 175x13	500x14 550x14 155x14	165/70x14 175/65x14							
10.30.0140	640x13		640x13 650x13		185/70x14 155x15 600x15 185/65x15								
10.30.0150	725x13		725x13 640x13C 670x13 695x13	700x13 750x13 D70x13 185x13	695x14 700x14 735x14 D70x14	E70x14 175x14 185x14 185x14AS	550X15 640X15 700/S/15L 175x15	180x15 165x15SR 195/65x15 185/70x15	550x16 575x16 400x17	450x19 155x400 155x400AS 165x380AS	165x400 175x355 175x380 180x380		
10.30.0160	750x14				750x14 775x14 185x14R[C]	195x14R 195/70x14 185/75x14	650x15 670x15 195/70x15	205/60x15 175/75x15 205/65x15	575x16 600x16J 195/65x16	185x380 17x380 17x400			
10.30.0170	650x16						215/65x15		195/75x16 650x16 205/65x16C 600x17				
10.30.0175	700x15				650x14 800x14 205/75x14		700x15 710x15 205/70x15 215/75x15		600x16P 640x16				
10.30.0180	700x16				850x14 900x14 950x14		700x15P 750x15 760x16 1.78x15 820x15		670x16 700x16				
10.30.0185	205x15				195x14C 205/70x14		205/75x15		195/65x16				
10.30.0190	750x16				215/75x17,5		750x15C		750x16	195x70 215x70			
10.30.0200	845x15				215X14		845x15G 70x15 L.78x15	195/65x15 195x15 225/70x15	225/60x16 235/60x16 225/55x16 215/65x16	600x20			
10.30.0210	600x18						225/75x15 235/75x15 225/60x15 225/70x15C	205x16 225x16 225/70x16 235/70x16	225/75x16 205/75x16 215/75x16 235/65x16	600x18 650x18			





KAR ZİNCİR GRUBU / SNOW CHAIN GROUP

Merdiven Tipi Serme Seri / Ladder-Type
Snow Chains

OTOBÜS, KAMYON VE TIR GRUBU ·
BUS, TRUCK AND SEMI-TRAILERS

SERME ÇELİK ZİNCİR



KAUÇUK GERGİ TERTİBATI
RUBBER TIGHTENING TOOL



ÇELİK MAHMUZ
V-BAR

- Kauçuk gergi tertibatı.
 - Mahmuzlu merdiven modeli.
 - Parlak çinko kaplamalı ve aşınmaya karşı sertleştirilmiş zincir.
-
- Rubber tightening tool.
 - V-bar ladder-type.
 - Zinc-electro galvanized and anti - wear heat treatment.

TÜRKİYE'DE İLK ÇELİK ZİNCİR

Sıradan zincirlere
göre 3 kat daha
dayanıklı





KAR ZİNCİR GRUBU / SNOW CHAIN GROUP

Merdiven Tipi Serme Seri / Ladder-Type
Snow Chains

ÜRÜN KODU	GRUP	JANT EBATLARI / RIM SIZES						
		12"	13"	14"	15"	16" - 18"	DiĞER	
10.40.0220	8,5x17,5	825x15	825x16 255/65x16	8,5x17,5 225/75x17,5 235/75x17,5	700x18	700x22,5 650x20		
10.40.0221	285/65x16	6 mm				265/75x16 275/70x16 285/65x16	285/60x17	
10.40.0222	245/75x17,5	8 mm				275/70x16 225/75x17,5 235/75x17,5	245/70x17,5 265/70x17,5 245/70x17,5 260/70x17,5 245/70x19,5	
10.40.0225	285/70x19,5					285/70x19,5 265/70x19,5		
10.40.0226	900x20					900x20 10R x22,5		
10.40.0230	1000x20					1000x20 900x22 975x22 1100x22,5	305/60x22,5 295/60x22,5 305/70x22,5 975x22,5	
10.40.0235	1050x20					11R x22,5 1050x20	295/80x22,5 315/60x22,5	
10.40.0240	1100x20					1100x20 1200x22,5 12R x22,5 1050x20	315/70x22,5	
10.40.0250	1200x20					1200x20 1125x20 1200R x22,5 1000x22 1050x22	1100x22 13R x22,5 315/80x22,5 365/80x22,5 385/65x22,5	11x24TR 900x24 1100R x24,5 305/75R x24,5
10.40.0255	1300x20					385/65x22,5 1200x22 1275x20	1050x24 1150x24 1200x24,5	
10.40.0260	1400x20						135x20 395/85x20 1400x20L	





KAR ZİNCİR GRUBU / SNOW CHAIN GROUP

Ağlı (Avusturya) Serme Seri
Netted (Austrian Type) Snow Chains

OTOBÜS, KAMYON VE TIR GRUBU ·
BUS, TRUCK AND SEMI-TRAILERS

SERME ÇELİK ZİNCİR



ZİNCİR GERGİ TERTİBATI
TIGHTENING TOOL



SARSINTISIZ SÜRÜŞ
QUIET RUNNING

- Zincir gergi tertibatı.
- Ağlı Avusturya modeli.
- Sarsıntısız sürüş.
- Parlak çinko kaplamalı ve aşınmaya karşı sertleştirilmiş zincir.

- Chain tightening tool.
- Netted Austrian type.
- Quiet running.
- Zinc-electro galvanized and anti - wear heat treatment.

TÜRKİYE'DE İLK ÇELİK ZİNCİR

Sıradan zincirlere
göre 3 kat daha
dayanıklı





KAR ZİNCİR GRUBU / SNOW CHAIN GROUP

Merdiven Tipi Serme Seri / Ladder-Type
Snow Chains

ÜRÜN KODU	GRUP	JANT EBATLARI / RIM SIZES						
		12"	13"	14"	15"	16" - 18"	DİĞER	
10.40.0220	8,5x17,5	825x15	825x16 255/65x16	8,5x17,5 225/75x17,5 235/75x17,5	700x18	700x22,5 650x20		
10.40.0221	285/65x16	6 mm				265/75x16 275/70x16 285/65x16	285/60x17	
10.40.0222	245/75x17,5	8 mm				275/70x16 225/75x17,5 235/75x17,5	245/70x17,5 265/70x17,5 245/70x17,5 260/70x17,5 245/70x19,5	
10.40.0225	285/70x19,5					285/70x19,5 265/70x19,5		
10.40.0226	900x20					900x20 10R x22,5		
10.40.0230	1000x20					1000x20 900x22 975x22 1100x22,5	305/60x22,5 295/60x22,5 305/70x22,5 975x22,5	
10.40.0235	1050x20					11R x22,5 1050x20	295/80x22,5 315/60x22,5	
10.40.0240	1100x20					1100x20 1200x22,5 12R x22,5 1050x20	315/70x22,5	
10.40.0250	1200x20					1200x20 1125x20 1200R x22,5 1000x22 1050x22	1100x22 13R x22,5 315/80x22,5 365/80x22,5 385/65x22,5	11x24TR 900x24 1100R x24,5 305/75R x24,5
10.40.0255	1300x20					385/65x22,5 1200x22 1275x20	1050x24 1150x24 1200x24,5	
10.40.0260	1400x20						135x20 395/85x20 1400x20L	





KAR ZİNCİR GRUBU / SNOW CHAIN GROUP

Ağlı (Avusturya) Serme Seri
Netted (Austrian Type) Snow Chains

OTOBÜS, KAMYON VE TIR GRUBU ·
BUS, TRUCK AND SEMI-TRAILERS



ZİNCİR GERGİ TERTİBATI
TIGHTENING TOOL

SERME ÇELİK ZİNCİR



SARSINTISIZ SÜRÜŞ
QUIET RUNNING

- Zincir gergi tertibatı.
- Ağlı Avusturya modeli.
- Sarsıntısız sürüş.
- Parlak çinko kaplamalı ve aşınmaya karşı sertleştirilmiş zincir.

- Chain tightening tool.
- Netted Austrian type.
- Quiet running.
- Zinc-electro galvanized and anti - wear heat treatment.

TÜRKİYE'DE İLK ÇELİK ZİNCİR

Sıradan zincirlere
göre 3 kat daha
dayanıklı





KAR ZİNCİR GRUBU / SNOW CHAIN GROUP

Ağlı (Avusturya) Serme Seri
Netted (Austrian Type) Snow Chains

ÜRÜN KODU	GRUP	JANT EBATLARI / RIM SIZES						
		12"	13"	14"	15"	16" - 18"	DİĞER	
10.50.0220	8,5x17,5	825x15	825x16 255/65x16	8,5x17,5 225/75x17,5 235/75x17,5	700x18	700x22,5 650x20		
10.50.0221	285/65x16	6 mm				265/75x16 275/70x16 285/65x16	285/60x17	
10.50.0222	245/75x17,5	8 mm				275/70x16 225/75x17,5 235/75x17,5	245/70x17,5 265/70x17,5 245/70x17,5 260/70x17,5 245/70x19,5	
10.50.0225	285/70x19,5					285/70x19,5 265/70x19,5		
10.50.0226	900x20					900x20 10Rx22,5		
10.50.0230	1000x20					1000x20 900x22 975x22 1100x22,5	305/60x22,5 295/60x22,5 305/70x22,5 975x22,5	
10.50.0235	1050x20					11Rx22,5 1050x20	295/80x22,5 315/60x22,5	
10.50.0240	1100x20					1100x20 1200x22,5 12Rx22,5 1050x20	315/70x22,5	
10.50.0250	1200x20					1200x20 1125x20 1200Rx22,5 1000x22 1050x22	1100x22 13Rx22,5 315/80x22,5 365/80x22,5 385/65x22,5	11x24TR 900x24 1100Rx24,5 305/75Rx24,5
10.50.0255	1300x20					385/65x22,5 1200x22 1275x20	1050x24 1150x24 1200x24,5	
10.50.0260	1400x20						135x20 395/85x20 1400x20L	





CKR TARIM
BEKCI

SNOW CHAIN

Address :

Atatürk Mah.Kaymakan Yusuf
Doğan Cd. No:28/2 Beydağ /
İzmir / TURKEY

Telephone :

+90 232 592 95 91

Mobile :

+90 535 820 12 34
+90 532 266 85 82

Web

www.ckr-agro.com

Email :

info@ckr-agro.com
export@ckr-agro.com

www.ckr-agro.com



Zincir Grubu

Chain Group

2k
23-24
Catalog

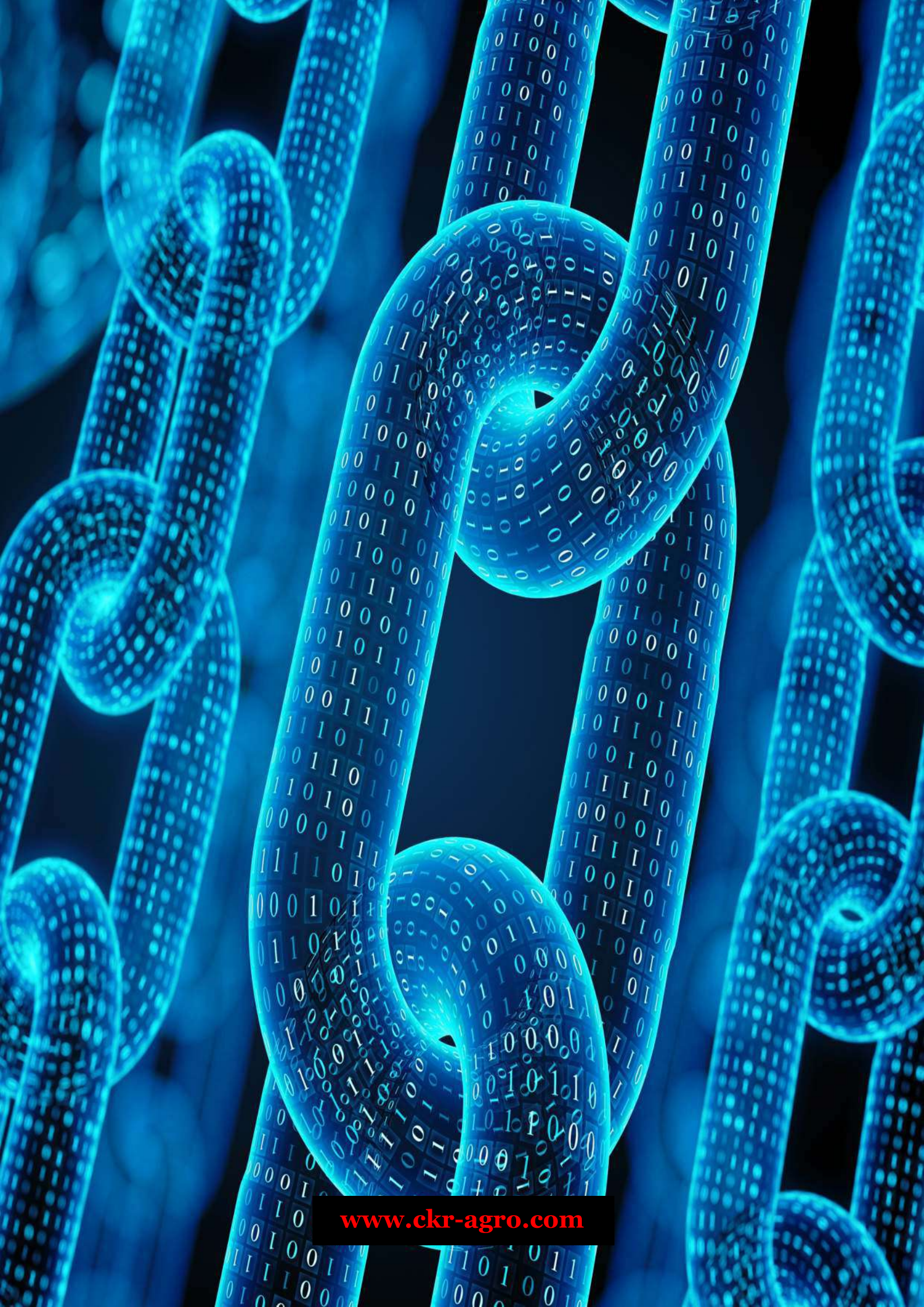

www.ckr-agro.com

**Zincir Ölçüleri / Chain Sizes**

Kod No.	Ø (mm)	W (mm)	H (mm)
YZ 2,00	2,00	13,00	3,50
YZ 2,50	2,70	15,50	4,60
YZ 3,00	3,40	18,00	6,00
YZ 4,00	3,90	20,00	7,00
YZ 5,00	4,90	26,50	8,50
YZ 6,00	5,90	29,00	10,00
YZ 7,00	7,00	28,00	12,50
YZ 8,00	8,00	32,00	14,00
YZ 9,00	9,00	36,00	16,50
YZ 10,00	10,00	40,00	18,00
YZ 12,00	12,00	48,00	20,00

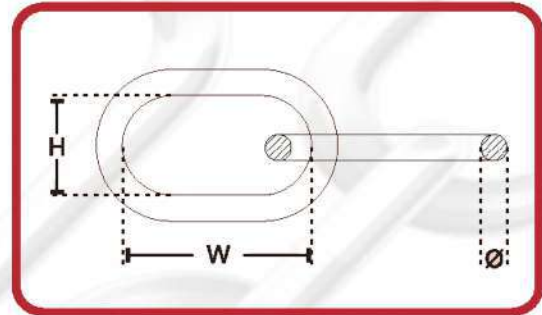



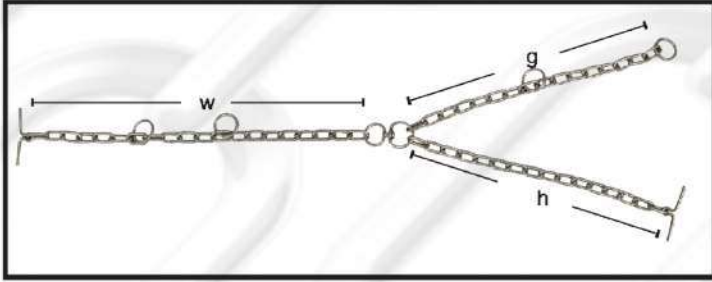

Kod No.	Ø	g(cm)	h(cm)	w (cm)
YZB-01	3,40	40	40	80
YZB-02	3,40	45	45	75
YZB-03	3,90	40	40	80
YZB-04	3,90	45	45	75
YZB-05	4,60	45	45	75
YZB-06	4,60	50	50	75
YZB-07	4,90	50	50	75
YZB-08	4,90	45	45	75
YZB-09	5,25	50	50	75
YZB-10	5,25	45	45	75
YZB-11	5,25	50	50	75
YZB-12	5,90	45	45	75
YZB-13	5,90	50	50	70





www.ckr-agro.com

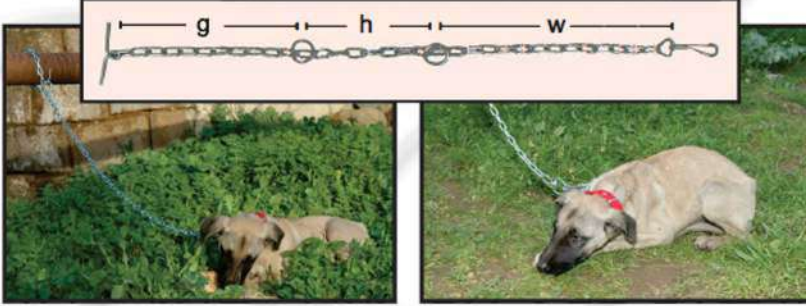

Kod No.	Ø	g (cm)	h (cm)	w (cm)
YZÇ-3120	3,40	30,0	30,0	60
YZÇ-3150	3,40	37,5	37,5	75
YZÇ-3200	3,40	50,0	50,0	100
YZÇ-4120	3,90	30,0	30,0	60
YZÇ-4150	3,90	37,5	37,5	75
YZÇ-4200	3,90	50,0	50,0	100
YZÇ-5120	4,90	30,0	30,0	60
YZÇ-5150	4,90	37,5	37,5	75
YZÇ-5200	4,90	50,0	50,0	100



Bükülü Zincir / Twisted Chain

20 No Düğümlü Zincir /
Knotted Chain



No.	Ø	h	f
8	3,00	16	15
10	3,40	20	14
11	3,40	21,5	14,7
12	3,90	25	19
14	4,00	28,5	20
16	4,00	30	20,5
18	4,20	35	25
20	4,40	40	27

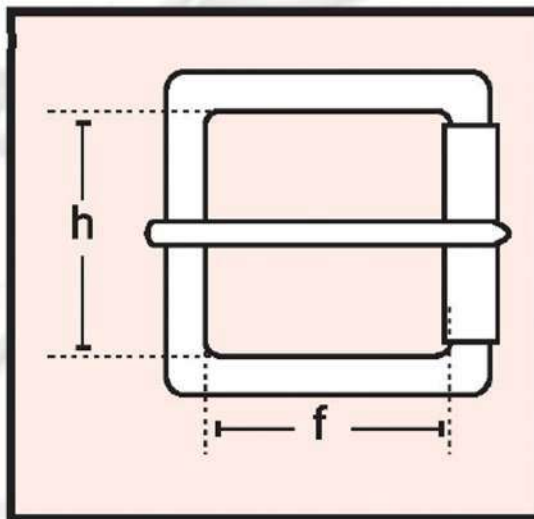



www.ckr-agro.com

Kaynaklı Toka / Welded Buckle

Ölçüler /
Dimensions (cm)

2,5
3
3,5
4
4,5
5
6



Eğimli Toka / Curved Buckle

3 cm

Ø 5 mm 30x30



D Toka / D Buckle

Ø 8 mm 45x90



Kaynaklı Toka (Çift Dilli) / Welded Buckle (Bilingual)

Ölçüler /
Dimensions (cm)

4
4,5
5
6



D Toka / D Buckle

Ø 7 mm 50x45



Eğimli Toka / Curved Buckle

2,5 cm

Ø 5 mm 25x25



Kaynaklı-Makaralı Toka / Welded-Roller Buckle

Ölçüler /
Dimensions (cm)

4
4,5
5





www.ckr-agro.com

12mm Kaynaklı Tekli /
Welded Single



12 mm



12 mm Kaynaklı
(Welding)



10 mm



10 mm Kaynaklı
(Welding)



6 mm



6 mm Kaynaklı
(Welding)





www.ckr-agro.com

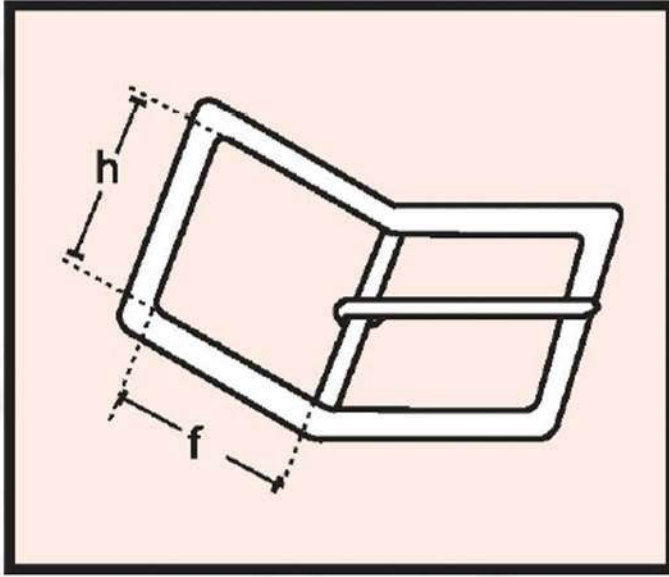

No.	Ø	h	f
20	3,50	20	16
25	4	25	19
27	4	27	19
30	4	30	20
35	5	35	23
40	5	40	24





www.ckr-agro.com

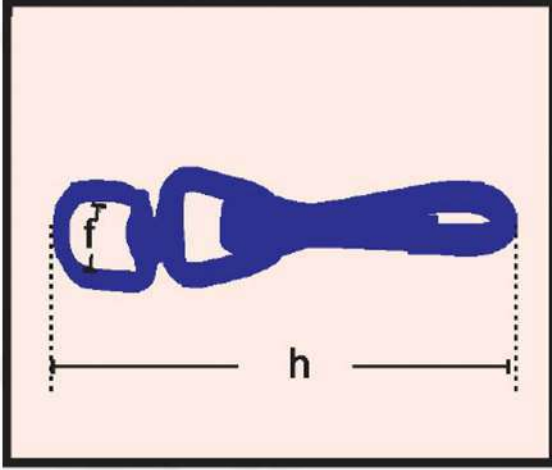

No.	Ø	h	f
40 DM	1,80	70	13,5
55 DM	2,00	105	23
65 DM	3,00	115	23
75 DM	3,50	130	23
100 DM	4,30	150	23



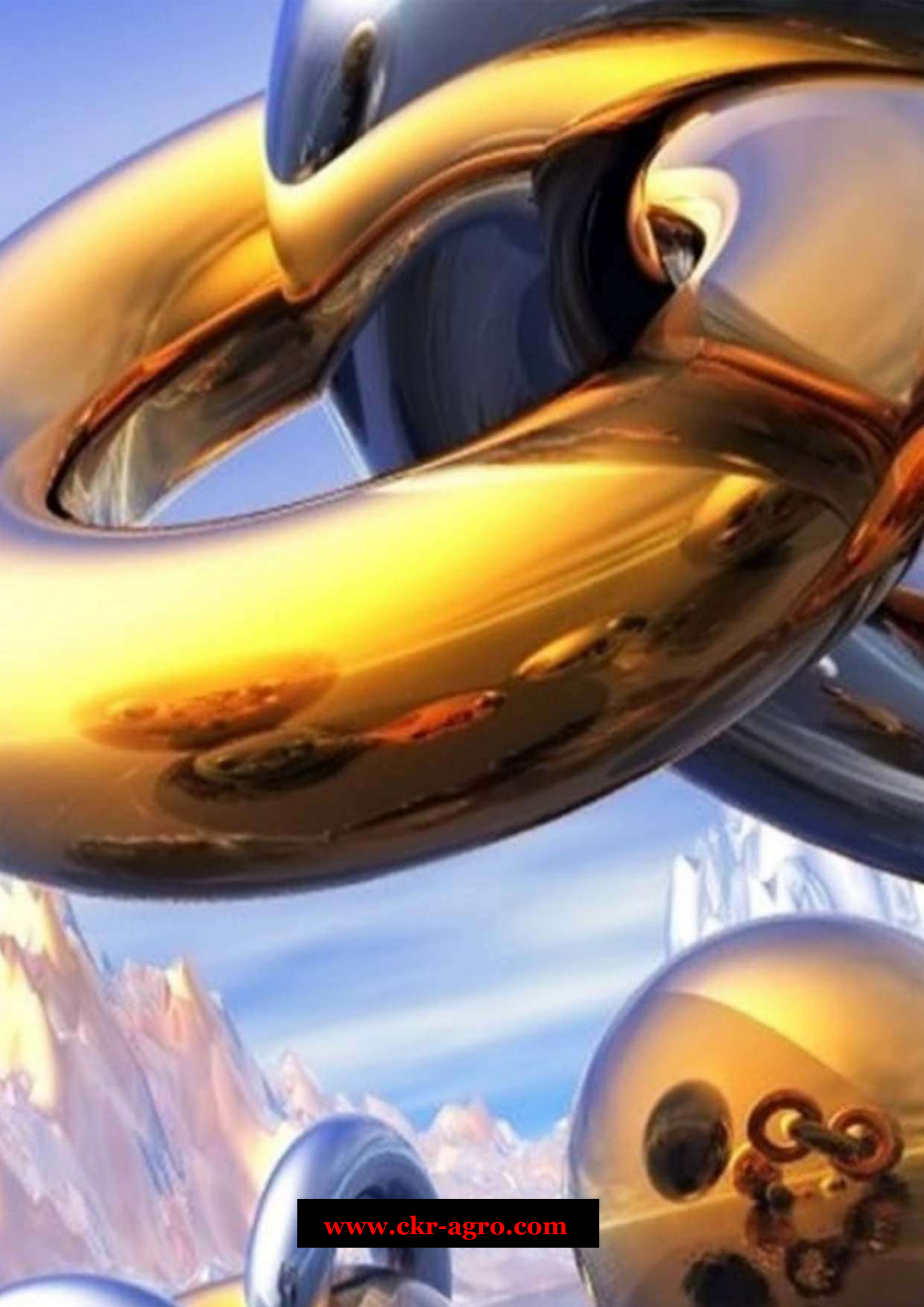

www.ckr-agro.com

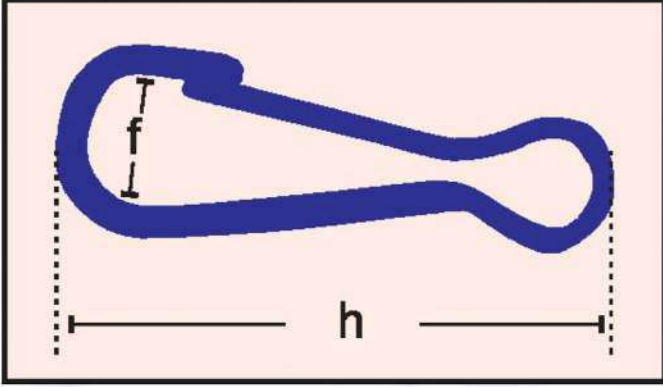

No.	Ø	h	f
40	1,80	40	10
55	2,00	55	11
65	3,00	65	15
75	3,50	75	16,5
100	4,30	100	21





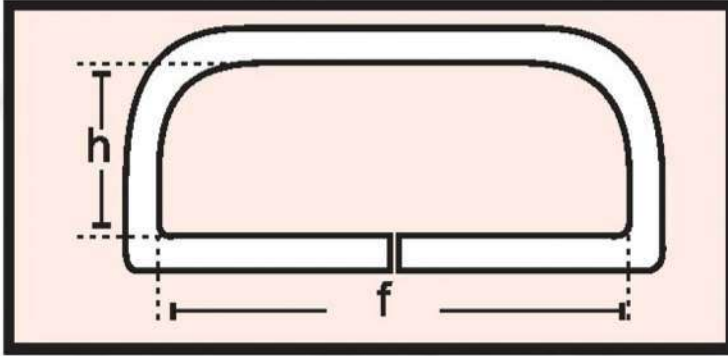

No.	Ø	f	h
2	1,80	20	12
2,5	1,90	25	12,5
3	2,00	30	15
3,5	2,00	35	16
4	2,30	40	16
4,5	2,30	45	16
5	2,30	50	17





www.ckr-agro.com

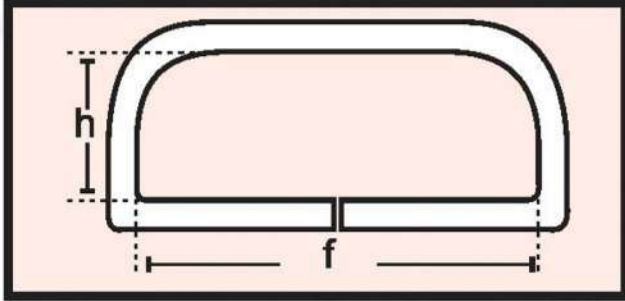

No.	Ø	f	h
1,5	1,70	15	8,5
2	1,70	20	10,5
2,5	1,70	25	10,5
3	1,75	30	11
3,5	1,80	35	12
4	2,00	40	12

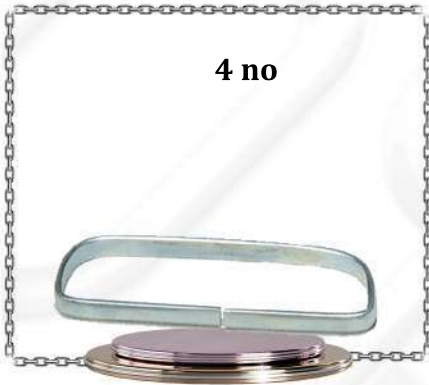



www.ckr-agro.com

6mm Karabina / Carabiner



Oval Halka / Oval Ring
7mm 73x34



Özel Kanca / Special Hook
4mm



Traktör Çeki Zincirleri / Tractor Draw Chains

**Çap / Uzunluk /
Diameter Length**

8 mm 150 cm
8 mm 200 cm
8 mm 300 cm
8 mm 400 cm

10 mm 200 cm
10 mm 300 cm
10 mm 400 cm
10 mm 500 cm





www.ckr-agro.com

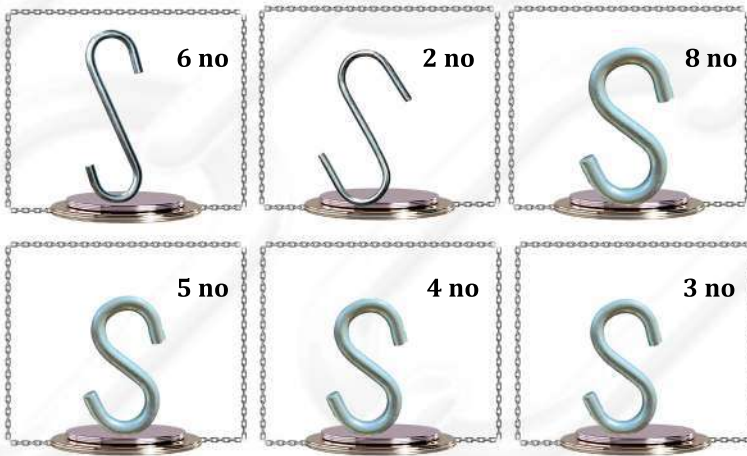

No.	Ø	f	h
2	2,00	38,5	10,5
3	3,30	34	10
4	3,80	40	11
5	4,80	40	11
6	5,90	103	20,5
8	6,40	54	17

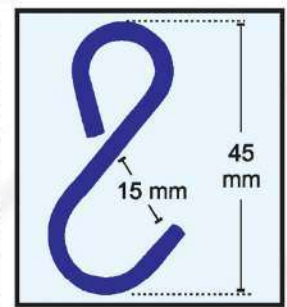
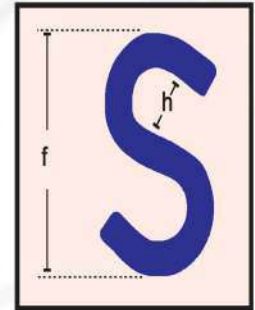



www.ckr-agro.com

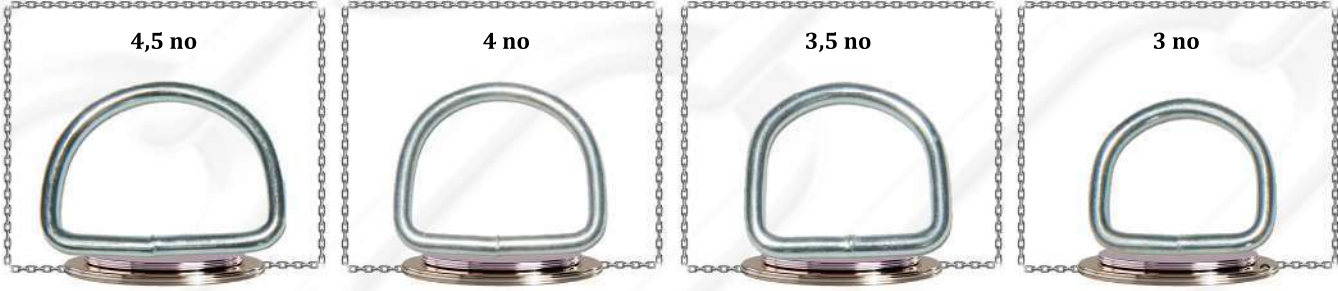

No.	Ø	f	h
1,5	3,00	15	14,5
2	3,30	20	13,5
2,5 alçak	3,90	25	15
2,5 yüksek	4,00	25	20

No.	Ø	f	h
3,00	4,50	30	24,5
3,50	4,90	35	30
4,00	5,00	40	33,5
4,50	5,00	45	33,5

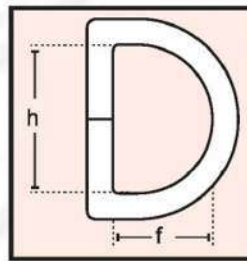

No.	Ø	h	f
8-55	7,80	55	46,5
7-35	6,80	35	30
7-45	6,80	45	32
7-50	6,80	50	42
6-35	5,90	35	57
4-35	4,00	35	57

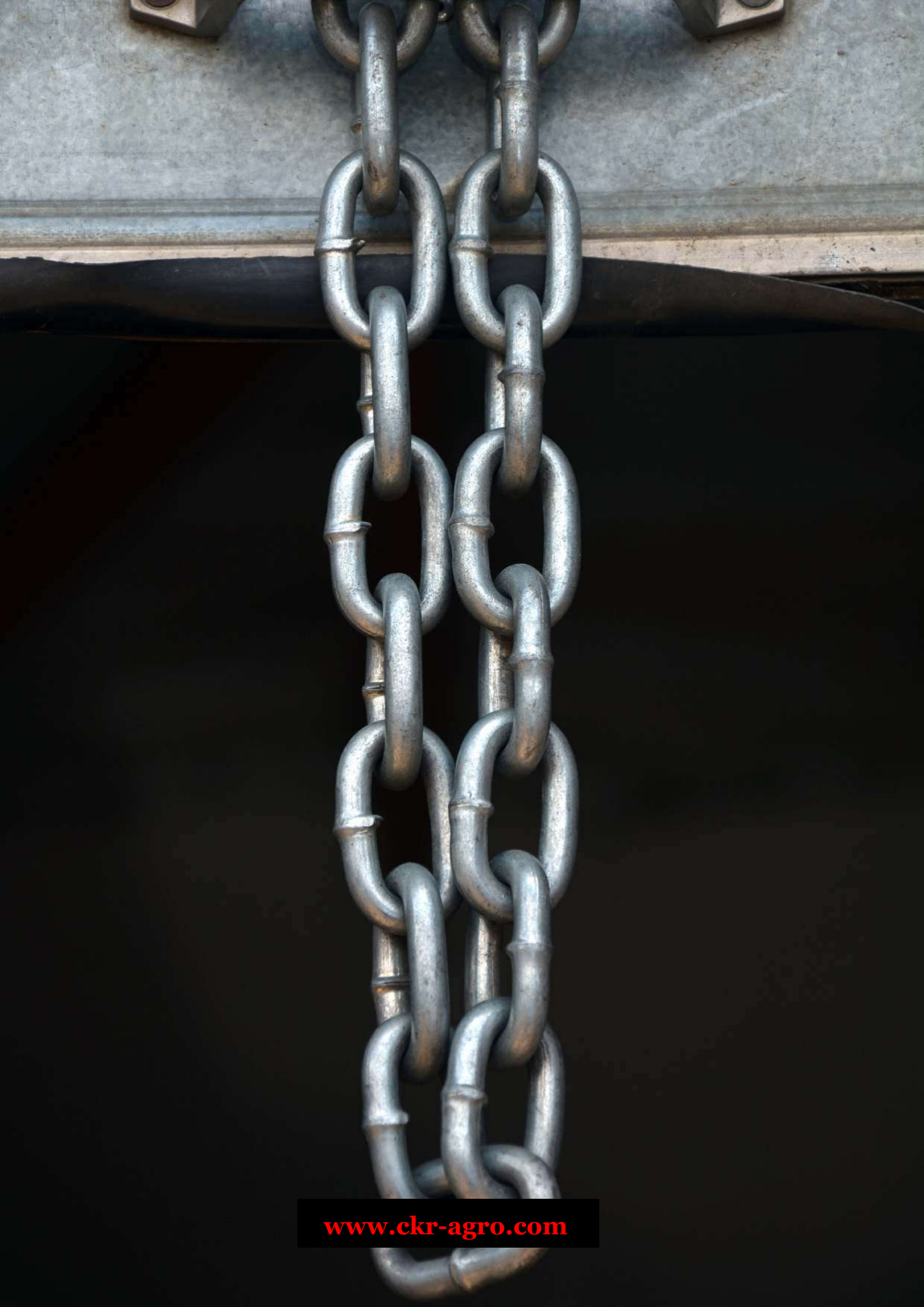

www.ckr-agro.com

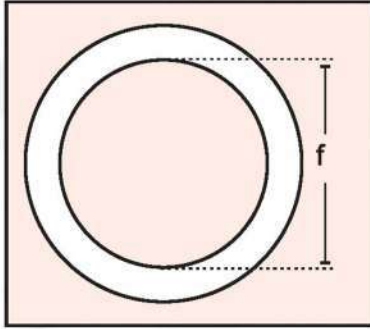

No.	Ø	f
8	2	13,5
10	2,50	20,0
12	3,30	25,0
14	3,50	28,0
16	3,90	30,0
18	4,40	35,0
20	4,75	40,0
22	4,90	45,0

No.	Ø	f
5-50	4,90	50,0
6-40	5,90	40,0
7-40	6,80	40,0
7-50	6,80	50,0
8-40	7,80	40,0
8-50	7,80	50,0
8-65	7,80	65,0
10-75	9,70	75,0



22 no



20 no



18 no



16 no



14 no



12 no



10 no



8 no



3 cm Saç Çivi /
3 cm Plate Nail



3,5 cm Saç Çivi /
3,5 cm Plate Nail



4 cm Saç Çivi /
4 cm Plate Nail



3cm Saç Çivi (Çiftli) /
3cm Plate Nail
(Double)



5 cm Saç Çivi /
5 cm Plate Nail

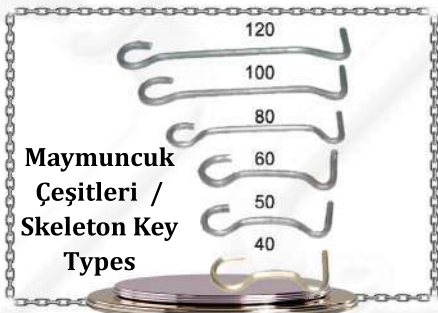

Maymuncuk
Çeşitleri /
Skeleton Key
Types

120
100
80
60
50
40



www.ckr-agro.com

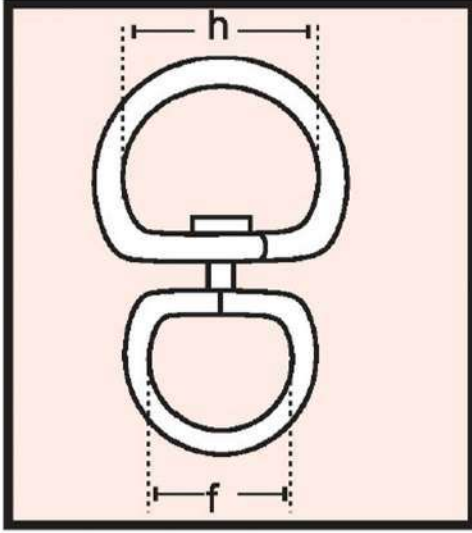

No.	Ø	h	f
4 mm küçük	3,80	22	19,5
4 mm	3,90	29,5	28
5 mm	4,60	34,5	26
6 mm	5,40	38	29,5
8 mm	6,40	38	30
10 mm	7,40	43,5	35



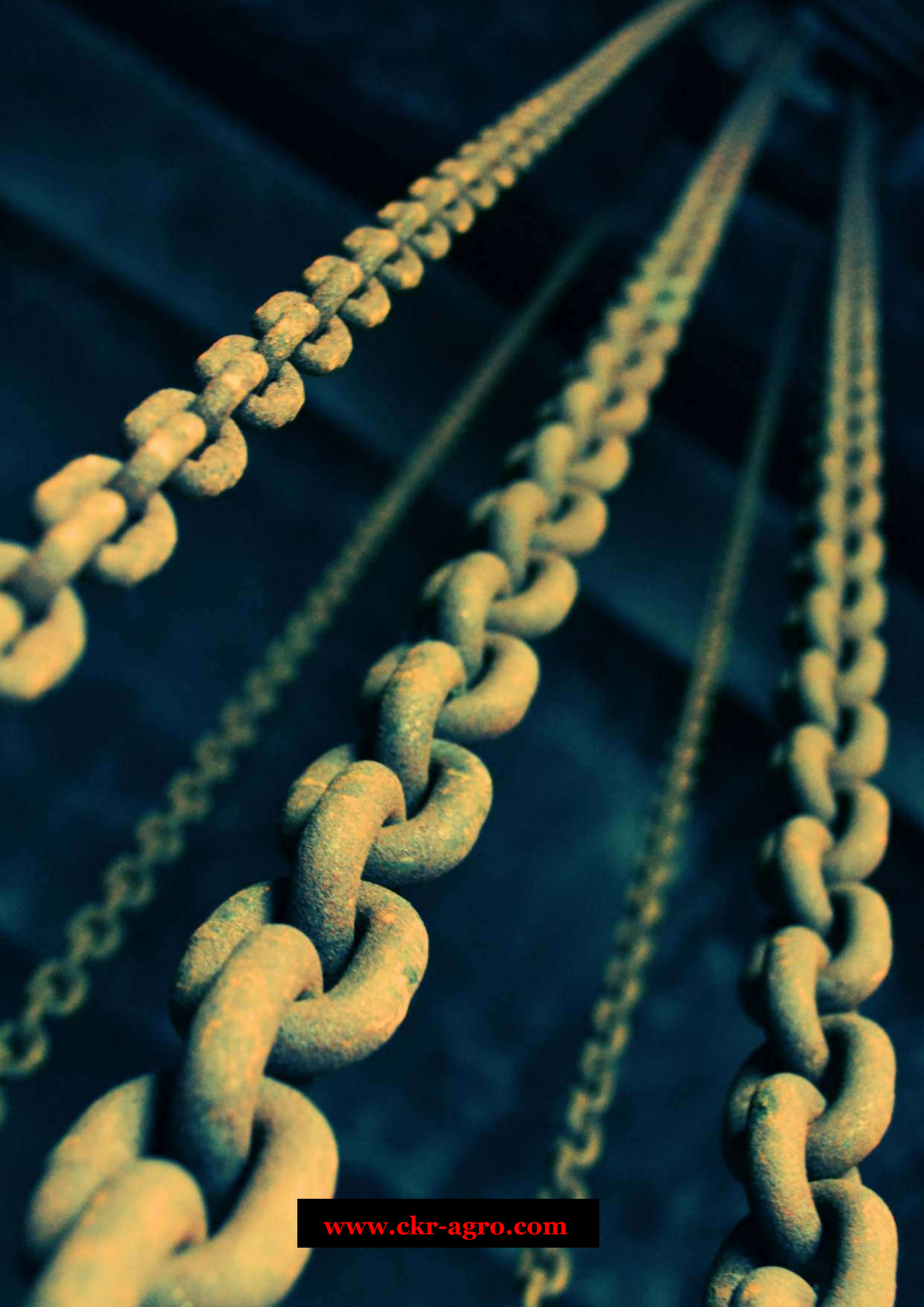

www.ckr-agro.com

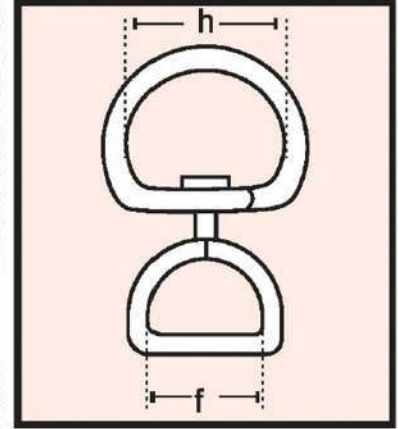

No.	Ø	h	f
4-20	3,80	22	20
4-27	3,90	29,5	27
4-30	3,90	29,5	30
5-30	4,60	34,5	30
6-35	5,40	38	35
6-40	5,40	38	40
6-45	5,40	38	45
8-45	6,40	38	45
10-50	7,40	43,5	50

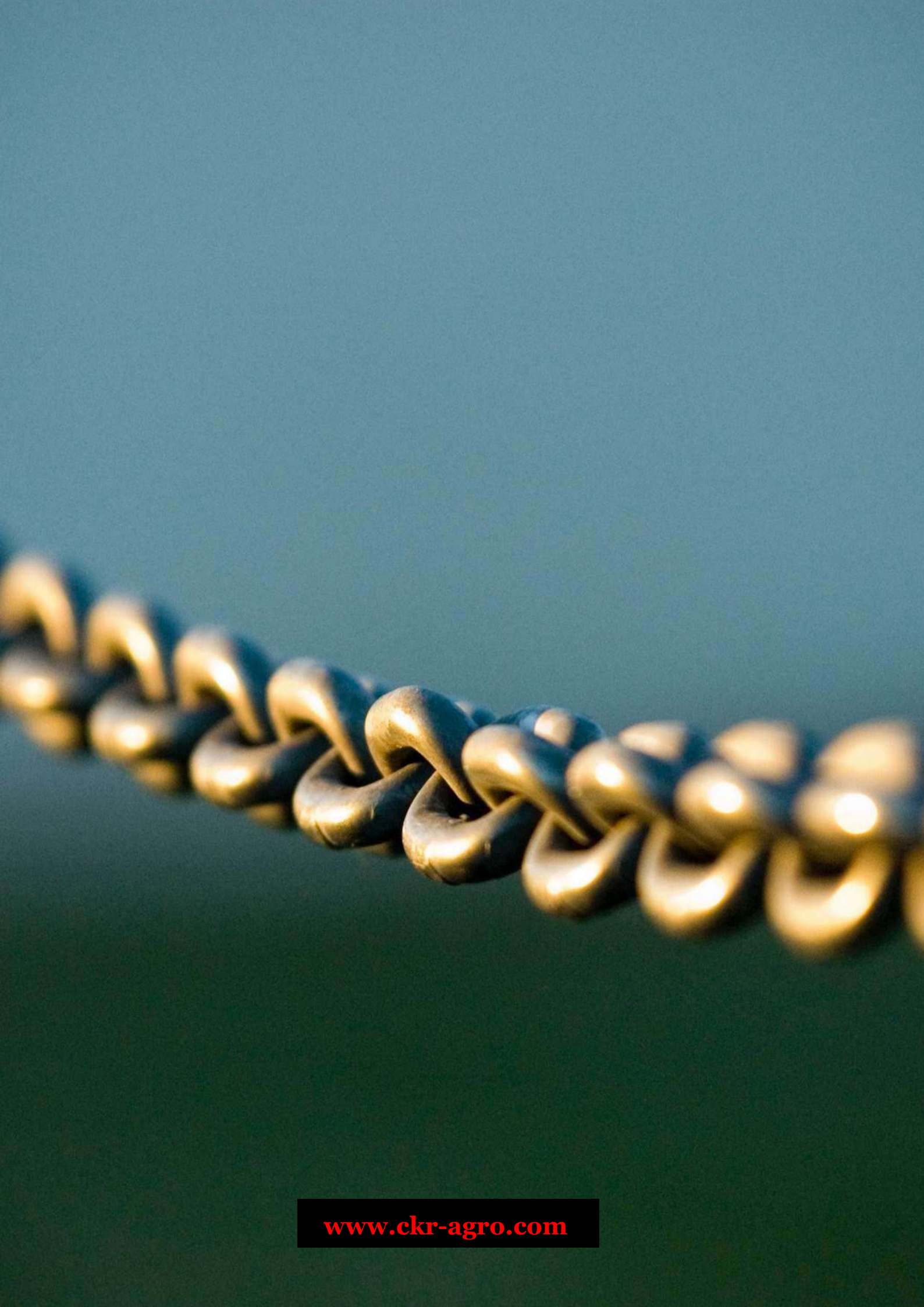

10 mm 35 no Üçgen (Triangle)



Gerdane / Halter Chain



Eğimli Çeki Tokası
Inclined Draw Clip



Üzengi / Stirrup



Acı Damak Gem Bridle



10 mm Halkalı Gem
10 mm Ringed Bridle



Üzengi / Stirrup



8-10 mm Et Çengeli
8-10 mm Meat Hook

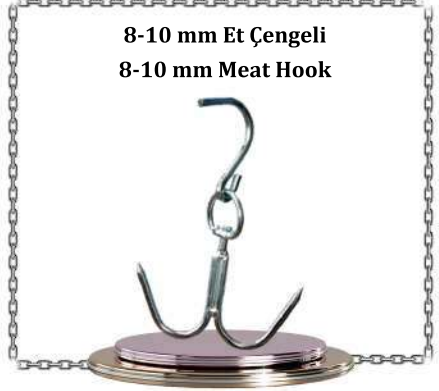

Bükülü /
Twisted

Çift Reşme /
Double Halter



At Ayırtma / Horse Halter

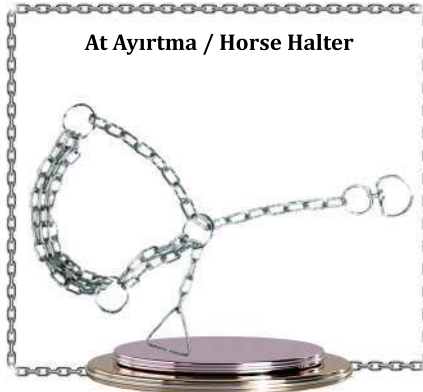

Demir Katır Yuları /
Iron Mule Halter

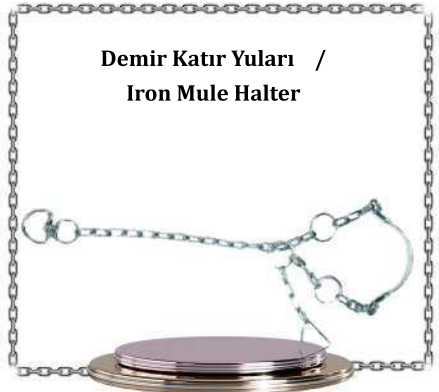



www.ckr-agro.com

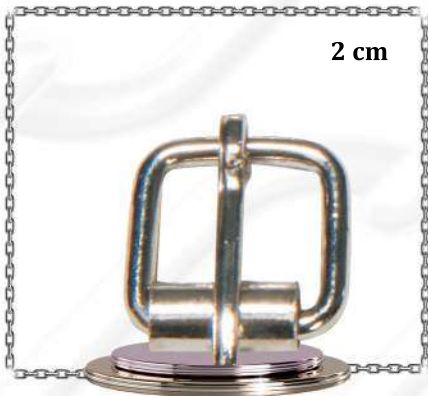
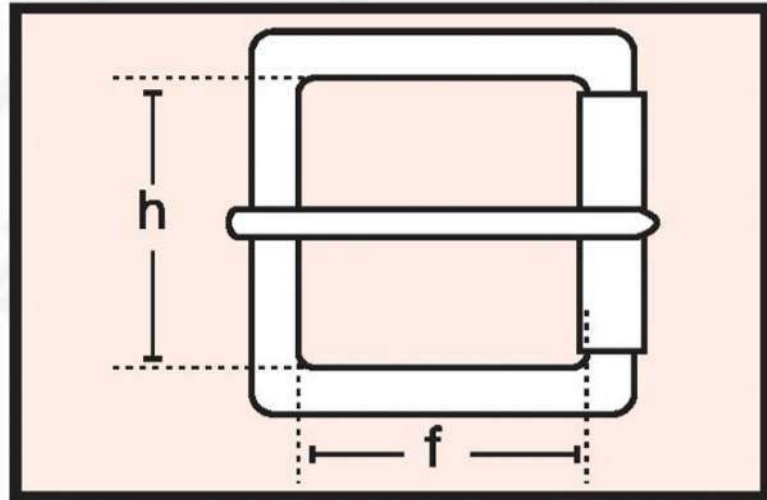

No.	Ø	h	f
2	3,40	20	14
2,5	3,90	25	19
3	4,00	30	20,5
3,5	4,00	35	25
4	3,00	40	20



www.ckr-agro.com

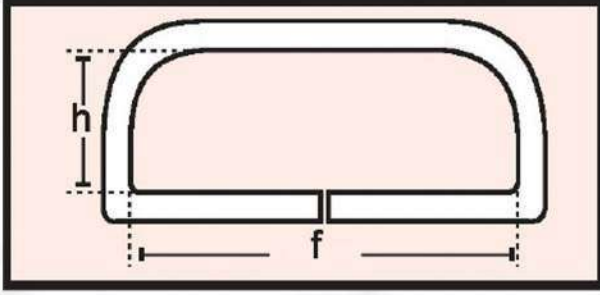

No.	Ø	f	h
2	1,70	20	10,5
2,5	1,70	25	10,5
3	1,75	30	11
3,5	1,80	35	12
4	2,00	40	12





www.ckr-agro.com









40x18x3,6

40 sürgülü/Sliding



38x18x3,0

38 sürgülü/Sliding



30x20x3,5

30 sürgülü/Sliding



25x19,5x3,5

25 sürgülü/Sliding



25x15x2,5

25 sürgülü/Sliding



20x16x3,4

20 sürgülü/Sliding



20x15x2,5

20 Dikey sürgülü/
Vertical Sliding



20x15x2,5

20 sürgülü/Sliding





www.ckr-agro.com





www.ckr-agro.com





AMBI NELLE



Çanta Aksesuarları (Nikel Kaplamalı) Bag Accessories (Nickel Plating)

Oval Halka Grubu / Oval Ring Group

38x16x5

30x16x5

25x15x5

22



www.ckr-agro.com



Çanta Aksesuarları (Nikel Kaplamalı) Bag Accessories (Nickel Plating)

Üçgen Grubu / Triangle Group

50x45x6



40x37x4



25x20x2,5



20x17x2,5



4 mm 25x25



4 mm 40x25



2



www.ckr-agro.com

320



Çanta Aksesuarları (Nikel Kaplamalı) Bag Accessories (Nickel Plating)

Kanca Grubu / Hook Group



22



www.ckr-agro.com

**Hayvan Yıkama Aparatı /
Ruination Attachnent**



Sentetik Kolon / Synthetic Column





Address :

Atatürk Mah.Kaymakan Yusuf
Doğan Cd. No:28/2 Beydağ /
İzmir / TURKEY

Telephone :

+90 232 592 95 91

Mobile :

+90 535 820 12 34
+90 532 266 85 82

Web :

www.ckr-agro.com

Email :

info@ckr-agro.com
export@ckr-agro.com

www.ckr-agro.com